

SURGE ARRESTOR (1/4 λ) N PLUG TO JACK

1. Description

Arrestor adopts "1/4λ" coaxial protection technology

Part NO.: SA(1/4)-N-PJ5002

Lighting and surge standard: IEC61643-21

2. Technical Data

ELECTRICAL DATA

Impedance	50 Ohm
Frequency range	800 — 960 MHz
VSWR	≤ 1.1
Max. peak power	500W
Contact resistance	≤ 1 mΩ (center contact), ≤ 0.25 mΩ (outer contact)
Insertion loss	≤ 0.1dB
Discharging current	≥ 15 kA@8/20μS
Residual Voltage	< 15 V@8/20μS



MECHANICAL DATA

Mating	5/8-24UNEF threaded coupling nut
Interface	N Plug to N Jack

ENVIRONMENTAL

Temperature Range	-40 °C to +70 °C
Relative Humidity	< 95%
Waterproof	IP 67

3. ATTENTIONS IN OPERATIONS

- The protector should be placed at the input to the installation and preferably near sensitive equipment.
- All protectors to be installed must be interconnected and connected with equipotential ground network.
- In order to minimize the residual voltages, the screws (M5x6) should be tightened up and the connection of the protector to the ground network should be as short as possible (less than 50cm) and has the largest possible cross-sectional area (at least 4mm²).

SURGE ARRESTOR (1/4 λ) N PLUG TO JACK

4. OUTLINE DRAWING

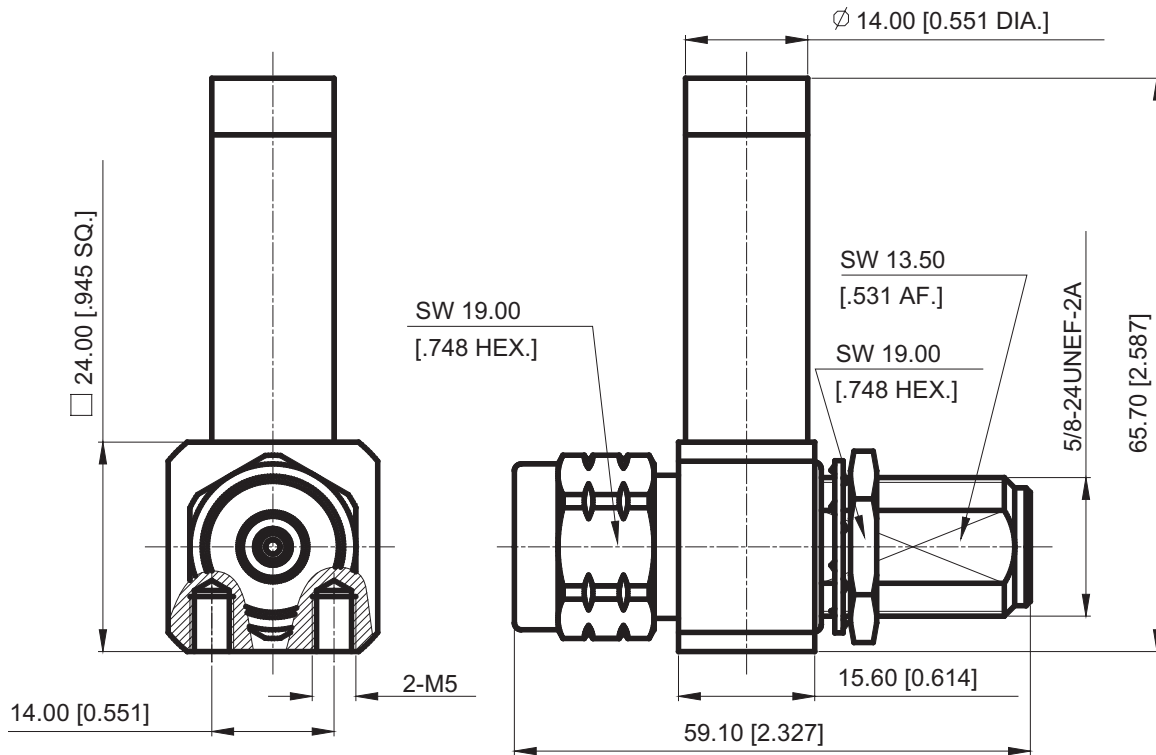

5. INSTALLATION ILLUSTRATION

