

REV	DESCRIPTION OF REVISION	ECN No.	BY	DATE	APPROVED
A	INITIAL RELEASE	—	H. Xiao	03/01/11	M. Dong

## TECHNICAL DATA

### Electrical data

Impedance	50 Ω
Frequency range	0~27 GHz
VSWR	1.10:1 (0~18GHz) 1.15:1 (18GHz~27GHz)
Contact resistance	
-centre contact	≤3mΩ
-outer contact	≤2mΩ
Insulation resistance	≥5000MΩ

### Mechanical data

Temperature range	-55 °C ~ +165 °C
Durability (matings)	>500

### Material data

Body	Stainless Steel (SU303), Passivated
Pin Contact	Beryllium Copper Alloy, Gold-plated
Insulator	PEI, PTFE

### Interface Standards

SMA	MIL-STD-348A
-----	--------------

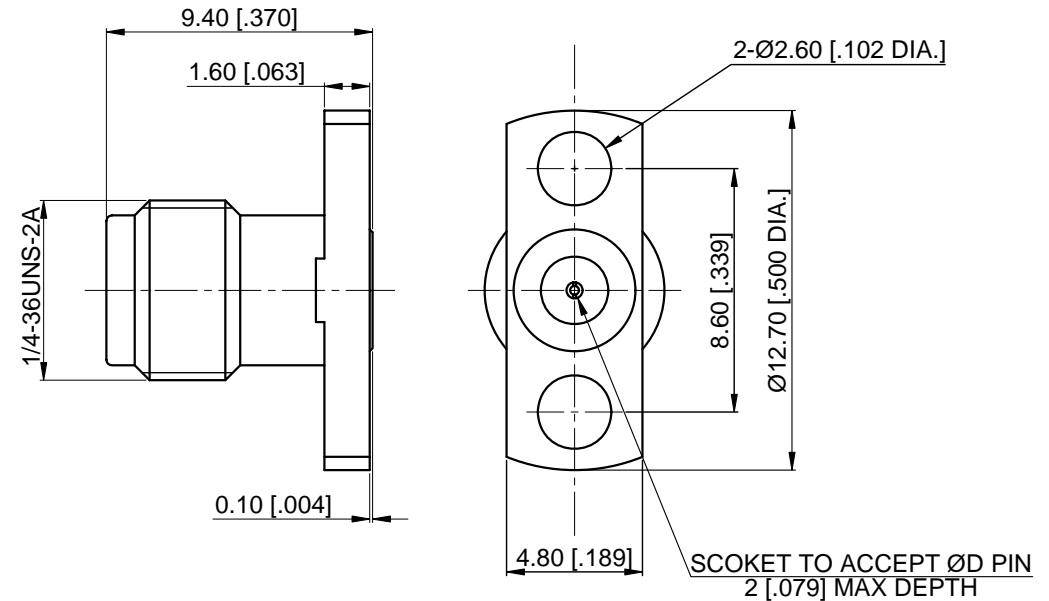

Part Number	ØD PIN
60-02-9E5-081A	0.23 [.009]
60-02-9E5-081B	0.30 [.012]
60-02-9E5-081C	0.38 [.015]
60-02-9E5-081D	0.46 [.018]
60-02-9E5-081E	0.51 [.020]

#### NOTES:

- ALL SPECIFICATIONS ARE SUBJECT TO CHANGE WITHOUT NOTICE AT ANY TIME
- CUSTOMER OUTLINE DRAWING FOR REFERENCE ONLY

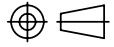
DRAWN: H. Xiao 03/01/11	TITLE:	 www.cmppter.com			
ENGINEER: YF. Zhu 03/01/11	SMA Straight Female, 2 Hole Flange, Accept Pin				
APPROVED: M. Dong 03/01/11		 DIMENSIONS IN MILLIMETERS (mm)			
TOLERANCE UNLESS OTHERWISE SPECIFIED	PART No.: 60-02-9E5-081				SIZE: A4
X ±0.50 [.019"]					
.X ±0.20 [.008"]					
.XX ±0.10 [.004"]					
ANGLES ±1°					